

This Quick Reference Guide illustrates the screens found in the SpeedDome Ultra IV Camera Dome Configuration Utility. The large numbers in the circles represent the number of the screen. The small numbers appearing to the right of the menu choices represent the screen you will see if you pick that choice. **Note:** The numbers in the circles do not actually appear on the screens. To start the configuration utility, do one of the following:

- For SensorNet or RS-422, press and hold **Iris Open**, press and hold a **Focus** button, then press **Zoom Out**.
- For Manchester, turn the key switch to **Prog** (or disable the system lock on the TOUCH TRACKER), use the keypad to enter **66**, then press **Set Shot**.

Refer to the keyboard or TOUCH TRACKER operating instructions for the locations of the control buttons.

1 DOME CONFIGURATION MENU

PAN/TILT/ZOOM OPTIONS **2**

CAMERA / LENS FUNCTIONS **3**

ALARMS / AREAS / HOME **4**

ON-SCREEN TEXT DISPLAY **5**

LANGUAGE / PASSWORD **6**

EXIT AND SAVE CHANGES

QUIT WITHOUT SAVING

RESET TO FACTORY SETTINGS

NOTE: If password protection is enabled, you must enter the password before the Dome Configuration Menu will display. Refer to screen **19** for information.

The following table describes the functions of the controls used to interact with the screens. Where a specific **Focus** button is not specified, either the **Focus Near** or **Focus Far** button may be used.

Function	Control
Display configuration menu (SensorNet and RS-422 only)	Iris Open, Focus, then Zoom Out
Display configuration menu (Manchester only)	Key switch to Prog, 66, then Set Shot
Save and exit utility from any screen (not supported with Manchester)	Iris Close then Focus
Moves highlight bar up	Tilt Up
Moves highlight bar down	Tilt Down
Moves highlight bar right	Pan Right
Moves highlight bar left	Pan Left
Selects the highlighted item	Focus Far
Increases the value or displays the next choice During naming, moves the cursor to the right of the current character in the name	Zoom In (Zoom Tele)
Decreases the value or displays the previous choice During naming, moves the cursor to the left of the current character in the name	Zoom Out (Zoom Wide)

2 PAN / TILT / ZOOM OPTIONS

PROPORTIONAL FLIP **OFF**

1ST ZOOM STOP X **24**

MAX TOTAL ZOOM X **128**

EXIT **1**

RESET TO FACTORY SETTINGS

3 CAMERA / LENS FUNCTIONS

LINE LOCK **OFF**

AGC MODE **ON**

AGC GAIN **112**

AUTO WHITE BAL **ON**

RED WHITE BAL **457**

BLUE WHITE BAL **563**

EXIT **1**

RESET TO FACTORY SETTINGS

Settings (Defaults in Bold)

Proportional Flip **ON** / OFF
 1st Zoom Stop X 16 / **24**
 Max Total Zoom X 32 / 48 / 64 / 80 / 96 / 112 / **128**

Settings (Defaults in Bold)

Line Lock **ON** / OFF
 AGC Mode **ON** / OFF
 AGC Manual Gain: 0 - 1128*
 Auto White Bal **ON**/OFF
 Red White Bal 128-1023**
 Blue White Bal 128-1023**
 * AGC Mode must be **OFF** to change
 ** Auto White Bal must be **OFF** to change



Select an item, then press **Focus Far** to make the changes.

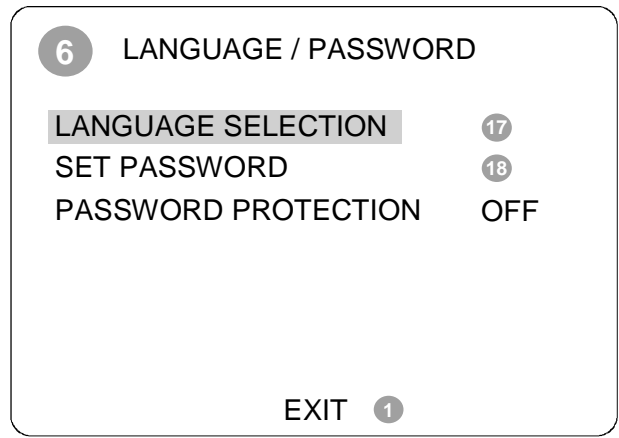

Press **Focus Far** to display Language Selection (screen 17) or Set Password (screen 18).

Settings (Defaults in Bold)

Password Protection ON / **OFF**

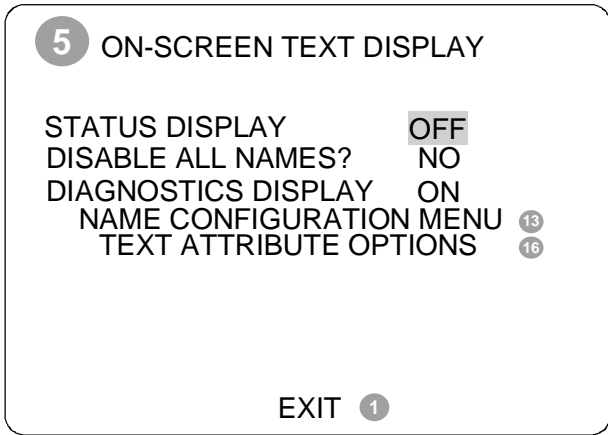

Settings (Defaults in Bold)

Status Display ON / **OFF**

Disable All Names? YES / **NO**

Diagnostic Display ON / **OFF**

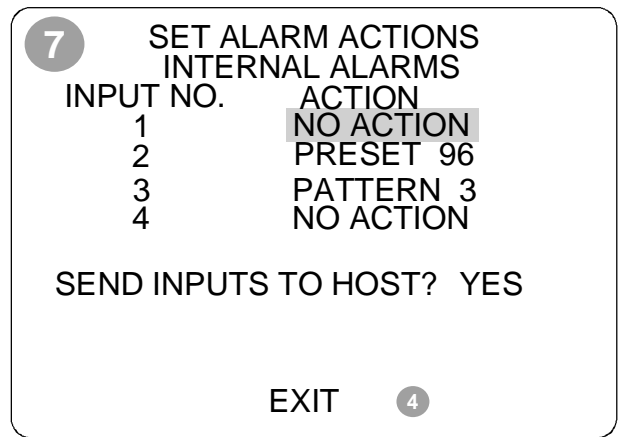

Settings (Defaults in Bold)

Input 1 - 4 Actions **NO ACTION** / PRESET / PATTERN

Send Inputs to Host? **YES** / NO

Preset Number 1-96; Pattern Number 1-3

Note: Do not assign input action on both dome and controller.

8 CONFIGURE NORMAL STATES

INPUT NO.	NORMAL STATE
1	OPEN
2	OPEN
3	CLOSED
4	OPEN

EXIT **4**

Settings (Defaults in Bold)

Input 1 - 4 Normal State **OPEN** / CLOSED

Note: Do not assign input action on both dome and controller.

11 SELECT PRESET TO PROGRAM

PRESET NUMBER	PRESET NAME
96	PRESET 96

EXIT **4**
 FOCUS FAR to program preset **12**

- Use **Zoom In** or **Zoom Out** choose the correct preset number.
- Press **Focus Far** to perform preset programming.

9 CONFIGURE HOME POSITION

HOME POSITION **PRESET 96**

RETURN TIME MINS **10**

If Preset is selected and no preset exists, you will see screen 12..

EXIT **4**

Settings (Defaults in Bold)

Return to Home Position **NO ACTION** / PRESET/ PATTERN

Return Time Mins 1 - 60 (Default is **10** minutes)

Preset Number 1-96; Pattern Number 1-3

10 PROGRAM AREA BOUNDARIES

PAN to start of BOUND **3**

PAN RIGHT ONLY

Press Focus Far twice to return to screen 4.

ZOOM to mark BOUNDARY
 FOCUS saves and exits

12 PROGRAM PRESET
 PRESET 1

Position camera with PAN,
 TILT, ZOOM, and IRIS

FOCUS FAR to save and exit
 EXIT **11 or 4**

This screen appears under two circumstances:

- By selecting a preset number and pressing **Focus Far** on the **Select Preset To Program** screen (see screen 11).
- By selecting a preset that has not been programmed as the **Home Position** (see screen 9).

Use **Pan, Tilt, Zoom, and Iris** controls to set the view for the preset. Press **Focus Far** when finished.

- Up to 16 areas can be programmed.
- Press **Zoom In** or **Zoom Out** to set area boundary
- Press **Focus Far** when finished setting areas

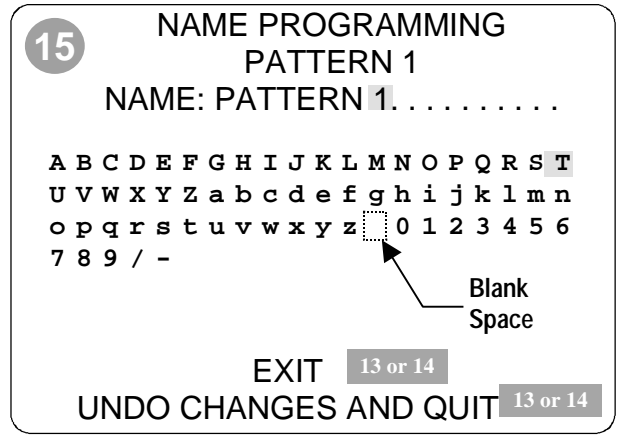
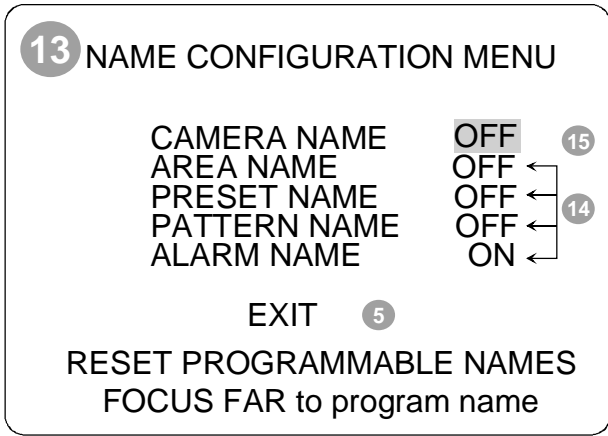

Settings (Defaults in Bold)

- Camera Name ON / **OFF**
- Area Name ON / **OFF**
- Preset Name ON / **OFF**
- Pattern Name ON / **OFF**
- Alarm Name **ON** / OFF
- Use **Zoom In** or **Zoom Out** to change setting for highlighted item.
- Press **Focus Far** to perform name programming for highlighted item. In this example, Camera Naming would be started.

Example Name Programming Screen (for Patterns)

- Names can have up to 19 characters
- Use **Zoom In** to move cursor one space to right in **Name**
- Use **Zoom Out** to move cursor one space to left in **Name**
- Use **Pan** and **Tilt** to move highlight around character field
- Press **Focus Far** to accept highlighted character
- The **SPACE** character is located between **z** and **0 (zero)**

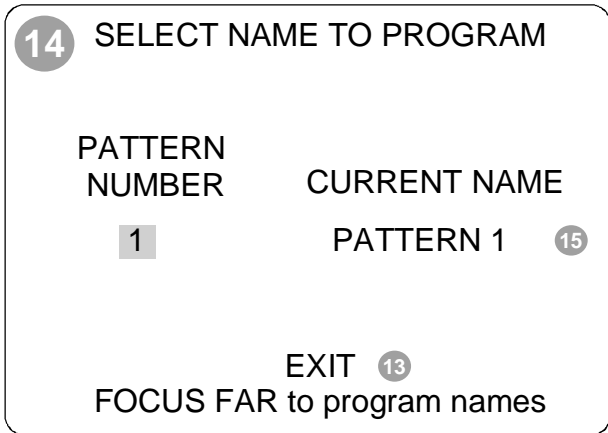

Example Select Name to Program Screen (for Patterns)

- Use **Zoom In** or **Zoom Out** choose the correct area, preset, pattern or alarm number.
- Dome moves to start of specified area, preset, or pattern (if programmed)
- Press **Focus Far** to display Name Programming Screen

Available Settings:

- Area Number 1-16
- Preset Number 1-96
- Pattern Number 1-3
- Alarm Number: 1-4

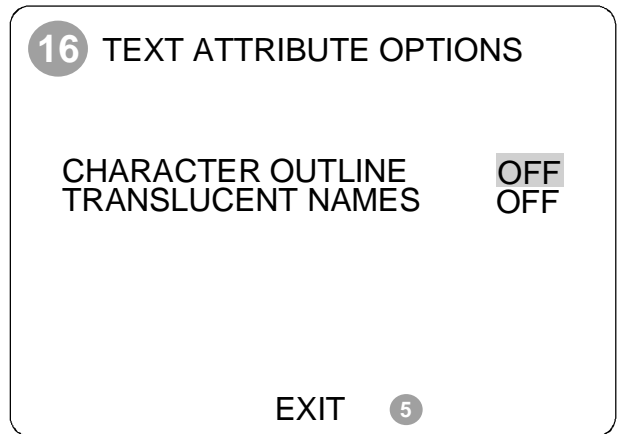

Settings (Defaults in Bold)

- Character Outline **ON** / OFF
- Translucent Names **ON** / OFF

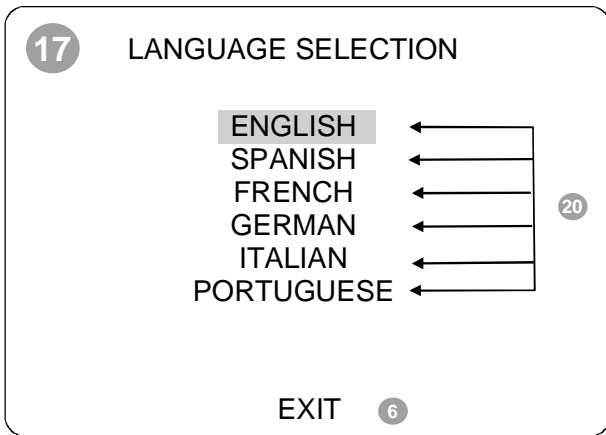

- Default setting is **English**.
- Characters **ã** and **õ** are not available in Portuguese.

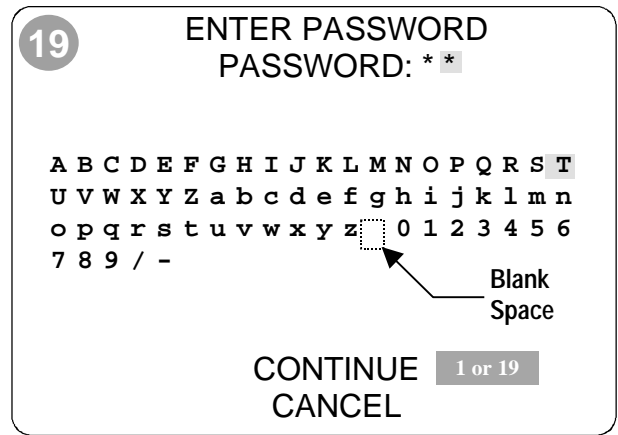

- Passwords can be from 1 to 8 characters.
- Asterisks appear when characters are selected.
- Use **Zoom In** to move cursor one space to right in **Password**
- Use **Zoom Out** to move cursor one space to left in **Password**
- Use **Pan** and **Tilt** to move highlight around character field
- Press **Focus Far** to accept highlighted character
- The **SPACE** character is located between the **z** and **0** (zero).
- To accept password, move highlight to **Continue**, then press **Focus Far**. If password is correct, screen 1 appears. Otherwise, Enter Password screen remains.
- To cancel password entry, move highlight to **Cancel**, then press **Focus Far**. The dome resumes normal operating mode.

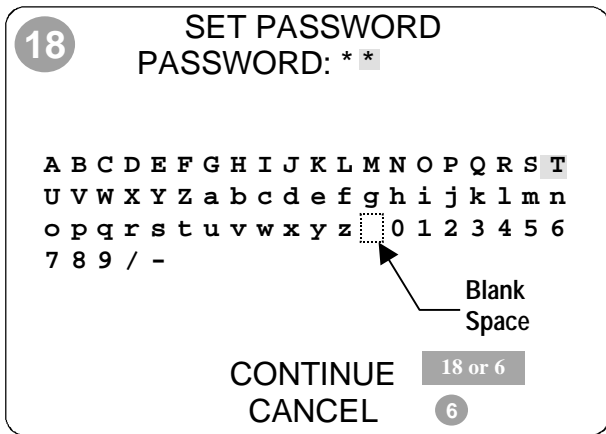

- Passwords can be from 1 to 8 characters.
- Asterisks appear when characters are selected.
- Use **Zoom In** to move cursor one space to right in **Password**
- Use **Zoom Out** to move cursor one space to left in **Password**
- Use **Pan** and **Tilt** to move highlight around character field
- Press **Focus Far** to accept highlighted character
- The **SPACE** character is located between the **z** and **0** (zero).
- To accept password, move highlight to **Continue**, then press **Focus Far**. **Re-enter for Verification** appears on screen.
- To cancel password programming, move highlight to **Cancel**, then press **Focus Far**.
- To set or change password, the same password must be entered twice. After 2nd successful entry, screen 6 appears
- **Password Protection** must be set to **ON** for password to be activated. See screen 6.

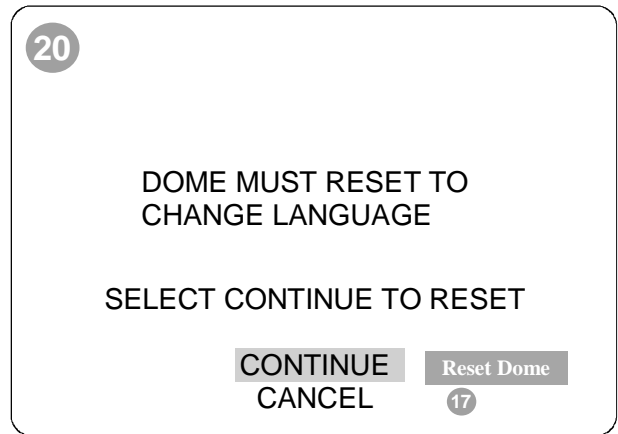

- Dome must reset for language change to occur. With highlight bar on **Continue**, press **Focus Far** to continue with language change.
- To cancel language change, use the **Tilt** control to move highlight bar to **Cancel**. The Language Selection screen (screen 18) displays.

Sensormatic, SpeedDome, and the Sensormatic logo are trademarks of Sensormatic Electronics Corporation. Other product names (if any) mentioned herein may be trademarks or registered trademarks of other companies.

No part of this guide may be reproduced in any form without written permission from Sensormatic Electronics Corporation.

© Copyright 1998. All rights reserved. BSL 9/98