



**WARNING : TO REDUCE THE RISK OF FIRE OR ELECTRIC SHOCK,
DO NOT EXPOSE THIS PRODUCT TO RAIN OR MOISTURE.**



**CAUTION : TO REDUCE THE RISK OF ELECTRIC SHOCK,
DO NOT REMOVE COVER (OR BACK);
NO USER-SERVICEABLE PARTS INSIDE
REFER SERVICING TO QUALIFIED SERVICE
PERSONNEL.**

 This lightning flash with arrowhead symbol within an equilateral triangle is intended to alert the user to the presence of uninsulated dangerous voltage within the product's enclosure that may be of sufficient magnitude to constitute a risk of electric shock to persons.

 The exclamation point within an equilateral triangle is intended to alert the user to the presence of important operating and maintenance (servicing) instructions in the literature accompanying the product.

WARNING: Do not install this equipment in a confined space such as a bookcase or similar unit.

CAUTION: The apparatus should not be exposed to water (dripping or splashing) and no objects filled with liquids, such as vases, should be placed on the apparatus.

**CAUTION : TO PREVENT ELECTRIC SHOCK,
DO NOT USE THIS PLUG WITH AN EXTENSION
CORD, RECEPTACLE OR OTHER OUTLET
UNLESS THE PLUG CAN BE FULLY
INSERTED WITHOUT EXPOSING ANY PARTS
OF THE BLADES.**

**Warning : This is a class A product . In a domestic environment this product
may cause radio interference in which case the user may be
required to take adequate measures.**

IMPORTANT COPYRIGHT INFORMATION: Many television programs and films are copyrighted. In certain circumstances, copyright law may apply to private in-home video taping of copyrighted materials.

MOISTURE CONDENSATION

If you pour a cold liquid into a glass, water vapor in the air will condense on the surface of the glass. This is moisture condensation. Moisture condensation on the head drum, one of the most crucial parts of the unit, will cause damage to the tape.

When the VCR is exposed to a rapid temperature change from cold to warm, some condensation will occur. Under this condition, connect the power cord to the AC line, press **POWER/TIMER** button on and allow at least two hours for the VCR to dry out.

The serial number is found on the back of this unit. This number is unique to this unit and not available to others. You should record requested information here and retain this guide as a permanent record of your purchase.

Model No. _____
Serial No. _____

FEATURES

- Time Lapse VCR Function
- Trigger Function
- Buzzer Function
- Auto Switcher Functionality
- Tape Compatibility
- Elapsed Time Display
- Series Recording Function
- Alarm Recording Function

CONTENTS

INTRODUCTION
Features/Contents3

PREPARATION
Control Names and Locations 4-8
Installation & VCR to Monitor and CCD
Camera Connection9
Multiplexer/Matrix Switcher Connections10-11
Alarm Record Connection12
Series Record Connection12
Setting the On Screen Display13
Setting the VCR SET UP Menu14
Setting the Set Time15
Video Cassette Tapes16

PLAYBACK
Normal Playback17
Special Effects Playback18-19
Tape Counter Memory Feature20

RECORDING
Normal Recording21
Repeat Recording22
Timer Recording23
Series Recording24
Alarm Recording25-26

ADDITIONAL INFORMATION
Check the Alarm Record Information27
Recording Time Table Information27
Check the Power Fail Recall28
Key Lock Function28
Self-Diagnosis29
Service Guide Table30
VIDEO Head Cleaning30
Troubleshooting31
Specifications32

Warning : The battery used in this device may present a fire or chemical burn hazard if mis-treated. Do not recharge, disassemble, incinerate, or heat above 212°F (100°C). Replace the battery with Matsushita Elec. Ind., Co., Ltd. (Panasonic) part no. VL2330 only. Use of another battery may present a risk of fire or explosion. Dispose of used batteries. Keep away from children. Do not disassemble or dispose of in fire.

CONTROL NAMES AND LOCATIONS

FRONT

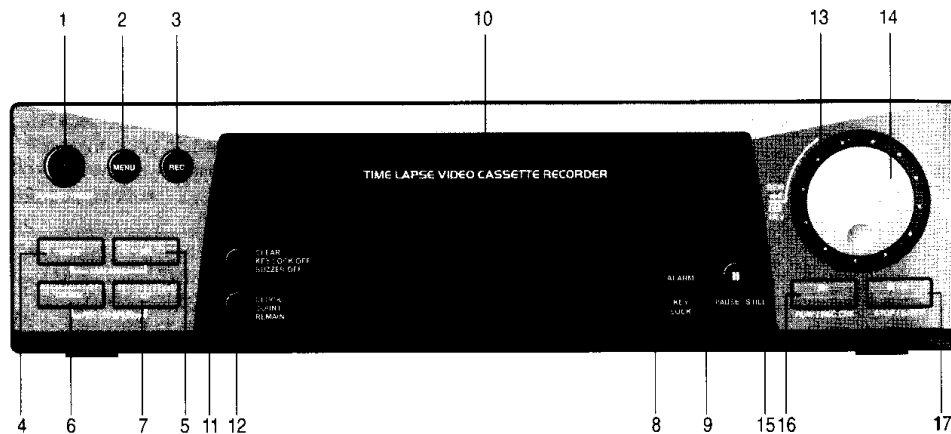
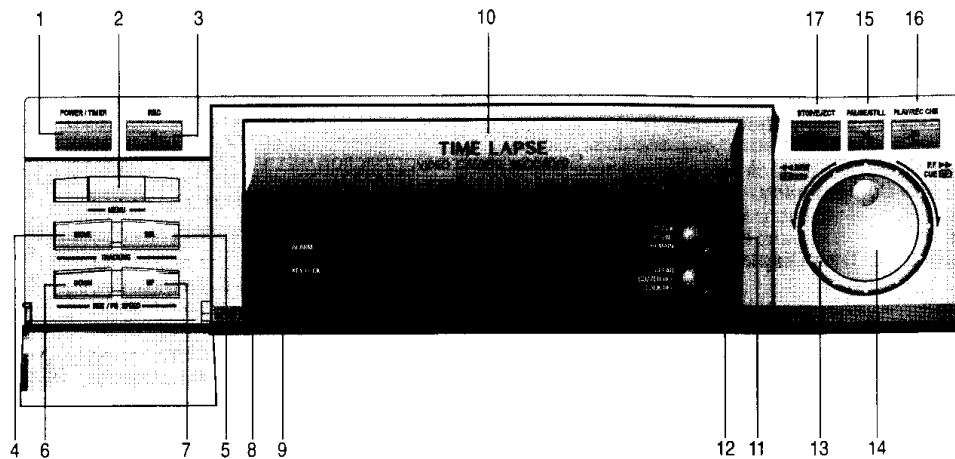

CONTROL NAMES AND LOCATIONS

FRONT

1. **POWER/TIMER button**
(Press for on; press again for off)
The display window becomes brighter when the VCR is switched on.
Press to select the timer program - on or off. By setting power off, a timer program is set to work.
2. **MENU button**
Press to display current status on TV screen. You can change its contents.
3. **REC (RECORD) button**
Press to begin recording.
4. **MOVE button**
Press to move the cursor down on menu screen or to operate tracking during playback or slow.
Press repeatedly to move the Time and Date display's position.
If a still picture vibrates vertically, stabilize it by pressing the MOVE button.
5. **SEL (SELECT) button**
Press to change the value or to operate tracking during playback or slow.
If a still picture vibrates vertically, stabilize it by pressing the SEL button.
6. **DOWN button**
Press to set speed in descending order 30H, 18H, 6H.... during recording or playback.
7. **UP button**
Press to set speed in ascending order 6H, 18H, 30H.... during recording or playback.
8. **ALARM Indicator**
Lights when alarm record is set on and blinks during alarm record.
It can be off by setting REC MODE to OFF under ALARM SET UP menu (only when there is no alarm record information on the ALARM RECALL menu. To erase the alarm record information, refer to "To erase the alarm record information" on page 27).
9. **KEY LOCK Indicator**
Lights during key lock mode is activated.
10. **Cassette loading slot**
Cassette tape is inserted in this slot.
11. **CLEAR, KEY LOCK OFF, BUZZER OFF**
Press to delete the information stored on screen display, such as Alarm recall, Power fail and Timer program.
It can also be used to stop the buzzer sound and to release key lock mode if it is held for at least 3 seconds.
12. **CLOCK, COUNT, REMAIN**
Pressing this button toggles between the CLOCK, COUNT, and REMAIN displays.
CLOCK shows the current time. COUNT shows the incremental counter for recording or playing, and REMAIN indicates the remaining time on the tape.
13. **Shuttle Ring**
Refer to page 19.
14. **Jog Ring**
Refer to page 19.
15. **PAUSE/STILL button**
When pressed during recording, tape movement stops temporarily. Press again to continue the recording.
When pressed during playback, tape movement stops. Press again to advance by still frame.
It can also be used to search alarm recording by pressing this button in stop mode.
16. **PLAY/REC CHECK button**
Press to play back a previously recorded tape. Press this button during recording to confirm the recording operation. It plays back the recording on screen 4 seconds and returns to recording mode.
17. **STOP/EJECT button**
Press once to discontinue all tape related functions. Press again to eject the cassette.

CONTROL NAMES AND LOCATIONS (cont'd)

REMOTE CONTROL

REAR

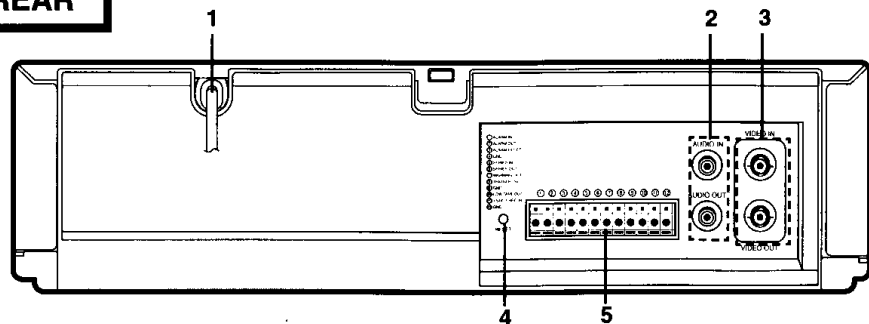

1. POWER CORD

Connect only to an AC 100-240V, 50/60Hz outlet.

2. AUDIO IN/OUT JACK

Connect the audio input and output terminal.

3. VIDEO IN/OUT JACK

Connect the video input and output terminal.

4. RESET BUTTON

Use this button to reset the VCR.

5. 12-PIN TERMINAL BLOCK

Connect external signals.

Terminal Signal Levels

TERMINAL	SIGNAL LEVEL	IN/OUT
1. ALARM IN	VIH: 4~5V, VIL: 0~0.6V T: above 250msec	INPUT
2. ALARM OUT	VOH: 4~5V, VOL: 0~0.6V T: ALARM REC STATE	OUTPUT
3. ALARM RESET	VIH: 4~5V, VIL: 0~0.6V T: above 250msec	INPUT
5. SERIES IN	VIH: 4~5V, VIL: 0~0.6V T: above 250msec	INPUT
6. SERIES OUT	VOH: 4~5V, VOL: 0~0.6V T: above 250msec	OUTPUT
7. WARNING OUT	VOH: 4~5V, VOL: 0~0.6V T: until any key is pressed	OUTPUT
8. TRIGGER OUT	VOH: 4~5V, VOL: 0~0.6V T: above 8~10msec	OUTPUT
10. LOW TAPE OUT	VOH: 4~5V, VOL: 0~0.6V T: below 5 min, end of tape	OUTPUT
11. 1-SHOT REC IN	VIH: 4~5V, VIL: 0~0.6V T: above 250msec	INPUT
4, 9, 12. GND	-	0V COMMON

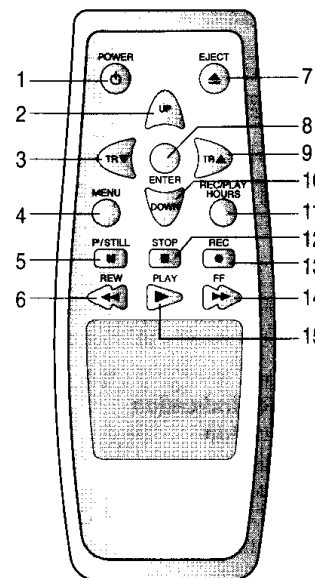

1. POWER button

(Press for on; press again for off)
The display window becomes brighter when the VCR is switched on. Press to select the timer program - on or off. By setting power off, a timer program is set to work.

2. UP button

Press to set speed in ascending order 6H, 18H, 30H.... during recording or playback.

3. TR ▼ button

To operate tracking during playback or slow. If a still picture vibrates vertically, stabilize it by pressing the TR ▼ button.

4. MENU button

Press to display current status on TV screen. You can change its contents.

5. P/STILL button

When pressed during recording, tape movement stops temporarily. Press again to continue the recording.
When pressed during playback, tape movement stops. Press again to advance by still frame.
It can also be used to search alarm recording by pressing this button in stop mode.

6. REW (Rewind)

To rewind the tape during the STOP mode or for fast reverse picture search during playback.

7. EJECT

Press to eject the cassette in the VCR.

8. ENTER (SELECT) button

Press to change the value or to operate tracking during playback or slow.

9. TR ▲ (MOVE) button

Press to change the value or to operate tracking during playback or slow. If a still picture vibrates vertically, stabilize it by pressing the TR ▲ button.

10. DOWN button

Press to set speed in descending order 30H, 18H, 6H.... during recording or playback.

11. REC/PLAY HOURS button

Press to set speed in ascending order 6H, 18H, 30H.... during recording or playback.

12. STOP

Press to discontinue all tape related functions.

13. REC (RECORD) button

Press to begin recording.

14. FF (Fast Forward)

To advance the tape during the STOP mode or for fast forward picture search.

15. PLAY (PLAY/REC CHECK) button

Press to play back a previously recorded tape. Press this button during recording to confirm the recording operation. It plays back the recording on screen 4 seconds and returns to recording mode.

CONTROL NAMES AND LOCATIONS (cont'd)

INDICATOR PANEL

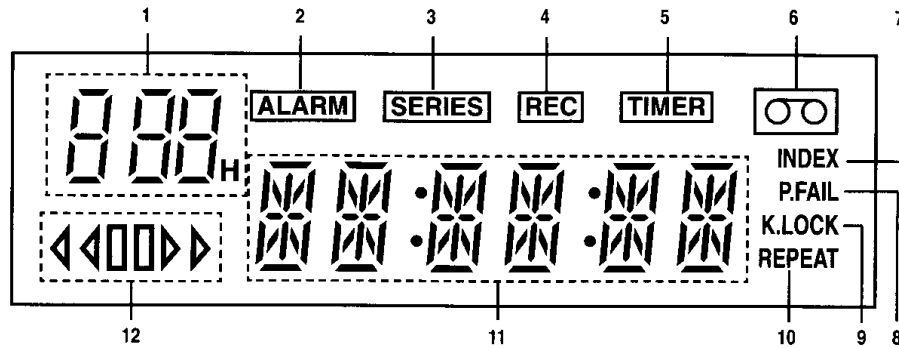

1. TIME LAPSE VCR TIME Indication
2. ALARM Indication (ALARM REC ON indication)
3. SERIES Indication
4. RECORD Indication
5. TIMER Indication
6. CASSETTE Indication
7. INDEX Indication
8. POWER FAILURE Indication
9. KEY LOCK indication
10. REPEAT Indication
11. FUNCTION Indication (CLOCK, TAPE COUNTER, ERROR)
12. VCR FUNCTION Indication

VCR FUNCTION Indication

PLAYBACK INDICATION		RECORDING INDICATION	
PLAYBACK	▶	RECORDING	▶ REC
PAUSE STILL	□□	TIMER RECORDING	▶ REC TIMER
FAST FORWARD	▶▶	ALARM INDEX	INDEX
REWIND	◀◀	ALARM RECORDING	ALARM
FORWARD SLOW PICTURE/ FORWARD FIELD ADVANCE	◻▶	SERIES RECORDING	SERIES
REVERSE SLOW PICTURE/ REVERSE FIELD ADVANCE	◀◻		
CUE	▶▶▶		
REVIEW	▶▶▶▶		

INSTALLATION

- Connect your VCR's AUDIO/VIDEO output jacks to the A/V input jacks on back of your monitor.
- If your monitor does not have A/V input jacks, exchange the monitor or TV for one with A/V input jacks.
- Connect the CCD camera to VCR's VIDEO input jack.

VCR TO MONITOR AND CCD CAMERA CONNECTION

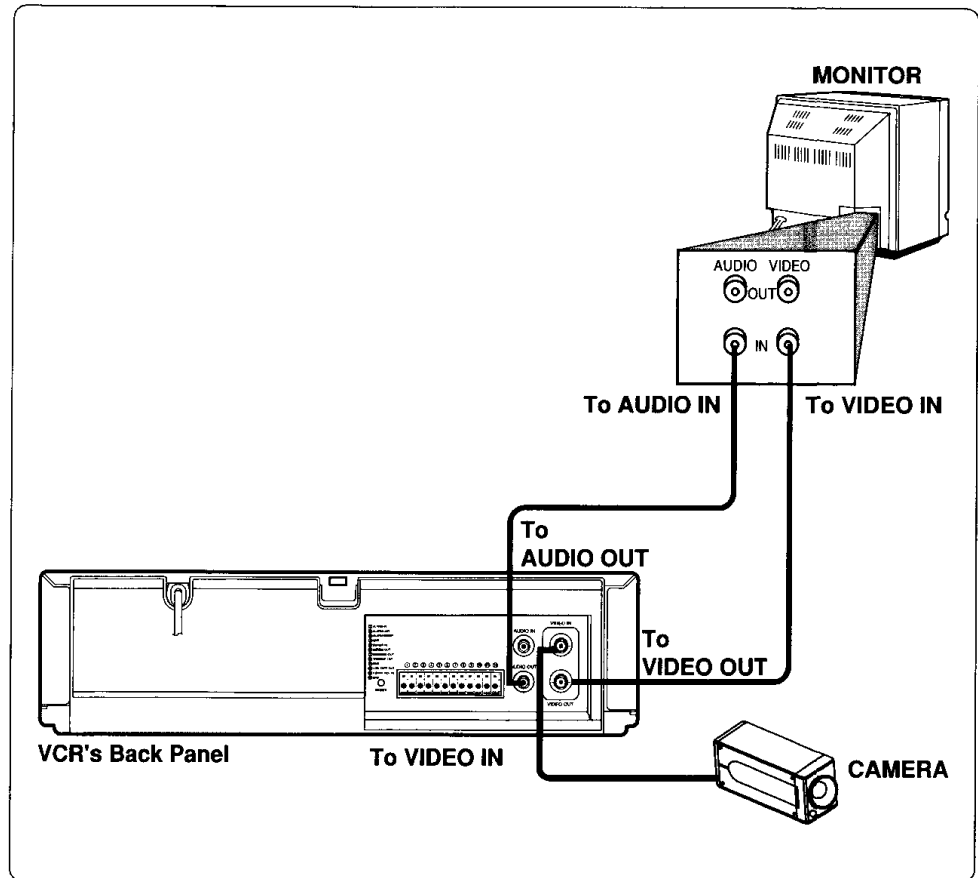

- The cables for audio and video connection are not provided with your VCR.

MULTIPLEXER CONNECTIONS

If the multiplexer has two output terminals (MONITOR OUT, PB OUT), connect monitor to the PB OUT terminal if you want to see the playback picture.

To use the multiplexer and trigger function properly, refer to the multiplexer instruction manual.

HOW TO CONNECT MULTIPLEXER WITH TRIGGER INPUT TERMINAL

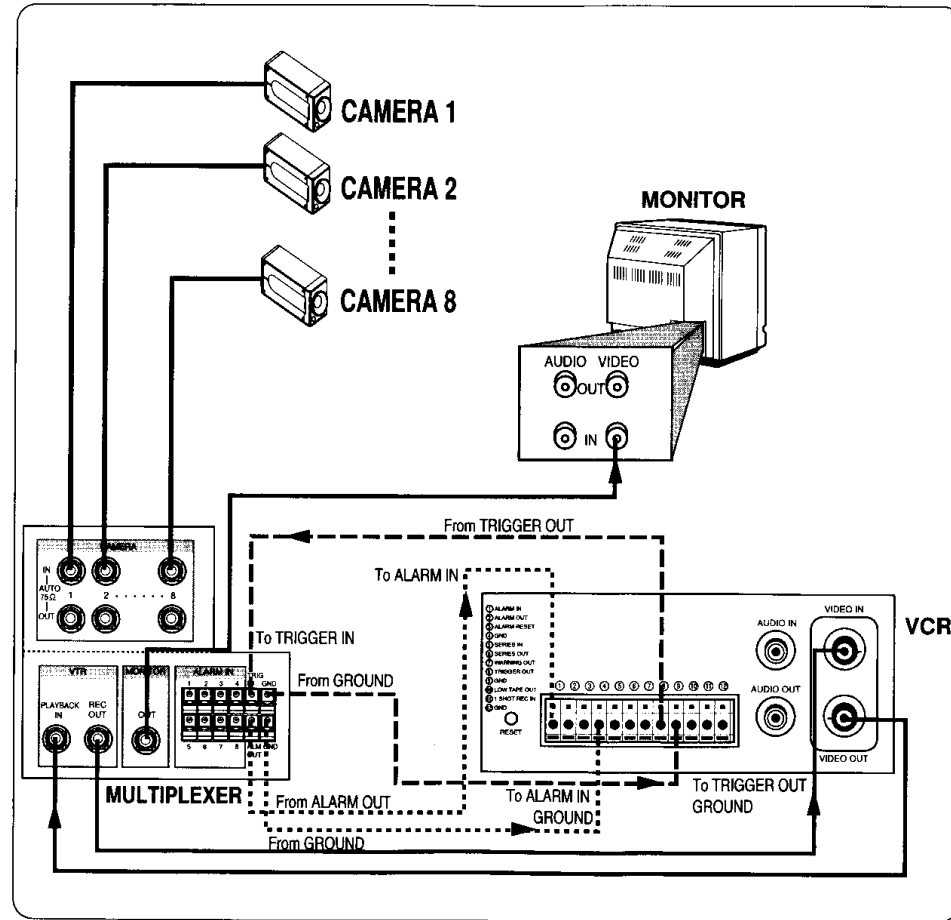

MATRIX SWITCHER CONNECTIONS

HOW TO CONNECT SWITCHER WITHOUT TRIGGER INPUT TERMINAL

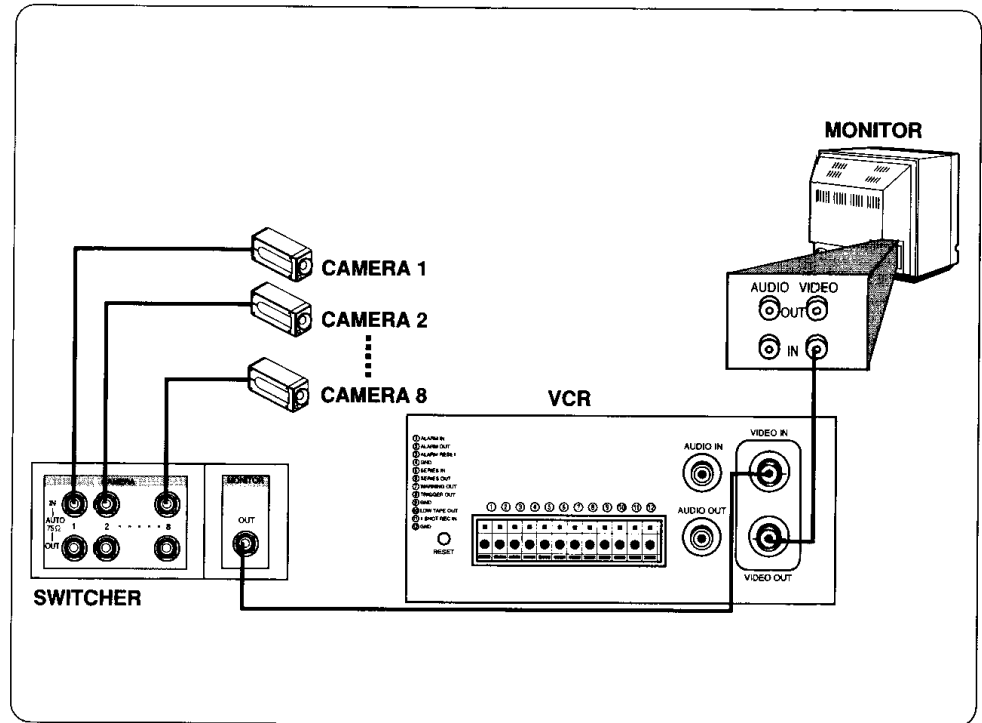

PREPARATION

PREPARATION

ALARM RECORD CONNECTION

Connect alarm output of external device to alarm input of VCR, and then connect alarm out GND of device to alarm input GND of VCR.

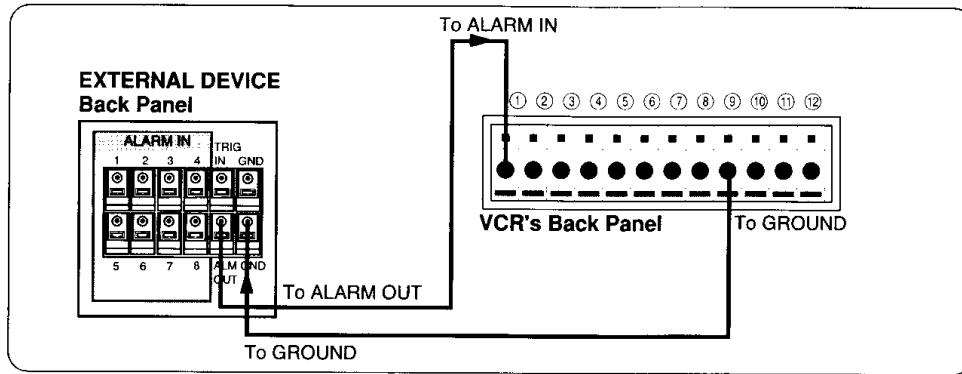

SERIES RECORD CONNECTION

Make all connections to the first VCR before making any connections to the other VCRs in the series.

After connecting, turn on the VCRs and then select the ON: SERIES mode in REC MODE menu. (Refer to the page 24.)

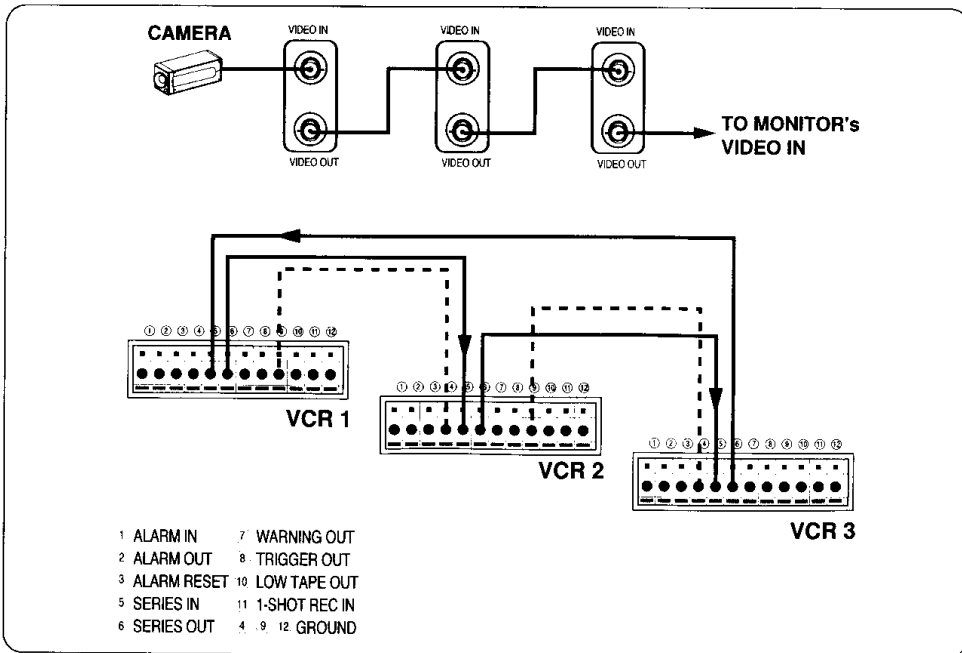

SETTING THE ON SCREEN DISPLAY

The following pages describe the on screen selections to be set.

PREPARATION

- Turn on the power of both the VCR and the monitor.
- If you have a TV instead of monitor, turn on the power of TV and then set the TV's source selector to VIDEO.

MENU SELECTION

Your VCR allows adjustment of several features.

1 Press **MENU** button and the main menu will appear.

2 Select the desired menu with the **MOVE** button and then press the **SEL** button.

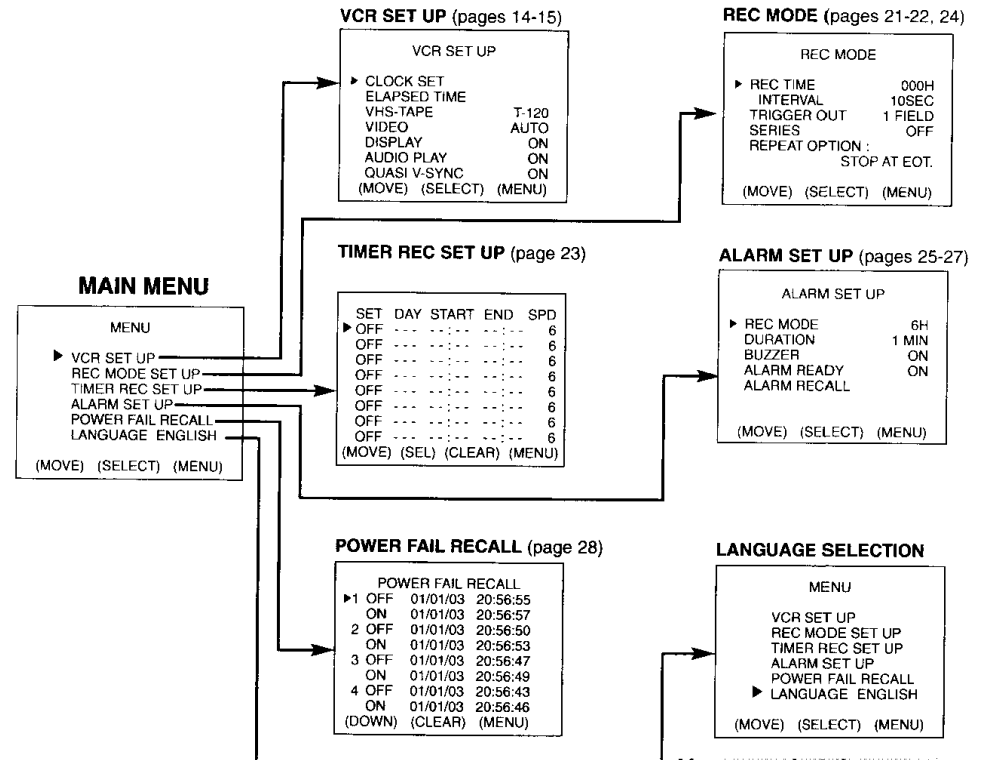

You can select the language among ENGLISH, FRANCAIS, DEUTSCH, ITALIANO, ESPAÑOL, POLSKI and ニホンゴ.

SETTING THE VCR SET UP MENU

MAIN MENU

```

MENU
▶ VCR SET UP
REC MODE SET UP
TIMER REC SET UP
ALARM SET UP
POWER FAIL RECALL
LANGUAGE ENGLISH
(MOVE) (SELECT) (MENU)
    
```

VCR SET UP MENU

```

VCR SET UP
▶ CLOCK SET
ELAPSED TIME
VHS-TAPE T-120
VIDEO AUTO
DISPLAY ON
AUDIO PLAY ON
QUASI V-SYNC ON
(MOVE) (SELECT) (MENU)
    
```

Press **MOVE** to choose a desired item on the **VCR SET UP** menu.

```

ELAPSED TIME
DATE OF FIRST USE:
01/01/03
PERIOD IN USE:
00004 HOURS
(MENU)
    
```

```

VCR SET UP
CLOCK SET
ELAPSED TIME
▶ VHS-TAPE T-120
VIDEO AUTO
DISPLAY ON
AUDIO PLAY ON
QUASI V-SYNC ON
(MOVE) (SELECT) (MENU)
    
```

PREPARATION

- Turn on the power of both the VCR and the monitor.
- If you have a TV instead of monitor, turn on the power of TV and then set the TV's source selector to VIDEO.

1 Press **MENU** button. The main menu will appear.
Press **MOVE** to choose **VCR SET UP**.

2 Press **SEL** button. The **VCR SET UP** menu will appear.

1. CLOCK SET

Details are on page 15.

2. ELAPSED TIME

Check the used time of head by pressing **SEL**.

3. VHS-TAPE

Choose the tape type used (T-120, T-160, T-180, T-210) by pressing **SEL**.

4. VIDEO

Choose the camera's color type (B/W, AUTO, COLOR) by pressing **SEL**.

5. DISPLAY

The time/date **DISPLAY** is switched between **ON** and **OFF** by pressing **SEL**.

6. AUDIO PLAY

The audio is switched between **ON** and **OFF** during playback by pressing **SEL**.

7. QUASI-SYNC

The quasi-sync is switched between **ON** and **OFF** during playback by pressing **SEL**.

SETTING THE SET TIME

Things to know before starting

- The clock uses the 24-hour system.
- The initial **SET DAY** Setting is **JANUARY 1, 2003**.

PREPARATION

- Turn on the power of both the VCR and the monitor.
- If you have a TV instead of monitor, turn on the power of TV and then set the TV's source selector to VIDEO.

1 Press **MENU** button. The main menu will appear.

2 Press **MOVE** to select the **VCR SET UP** item and then press **SEL**. The **VCR SET UP** menu will appear.

3 Press **MOVE** to select the **CLOCK SET** item and then press **SEL**. The **CLOCK SET UP** menu will appear.

4 Press **SEL** and then **DOWN** or **UP** to set a month and then press **SEL** to move to day item.

5 Press **DOWN** or **UP** to set a day and then press **SEL** to move to year item.

6 Press **DOWN** or **UP** to set a year and then press **SEL**.

The day of the week will display automatically.

7 Press **MOVE** to move cursor to **TIME** item and then press **SEL** to move to hour item.

8 Press **DOWN** or **UP** to set an hour and then press **SEL** to move to minute item.

9 Press **DOWN** or **UP** to set a minute and then press **SEL** to move to second item.

10 Press **DOWN** or **UP** to set a second and then press **SEL**.

11 Press **MENU** button when finished.

MAIN MENU

```

MENU
▶ VCR SET UP
REC MODE SET UP
TIMER REC SET UP
ALARM SET UP
POWER FAIL RECALL
LANGUAGE ENGLISH
(MOVE) (SELECT) (MENU)
    
```

VCR SET UP MENU

```

VCR SET UP
▶ CLOCK SET
ELAPSED TIME
VHS-TAPE T-120
VIDEO AUTO
DISPLAY ON
AUDIO PLAY ON
QUASI V-SYNC ON
(MOVE) (SELECT) (MENU)
    
```

CLOCK SET UP MENU

```

CLOCK SET UP
MM/DD/YY
▶ DATE 05 / 23 / 03 FRI
HH/MM/SS
TIME 17 / 30 / 00
(MOVE) (SELECT) (MENU)
    
```

```

12H
17 : 30 : 00
05 / 23 / 03
    
```

(TV screen/monitor)

Time and Date display position change

Press **MOVE** repeatedly until desired position is achieved. The Time and Date display moves clockwise.

VIDEO CASSETTE TAPES

SAFETY TAB

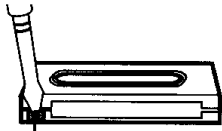

To prevent accidental erasure, remove the tab after recording.



To record again, cover the hole with vinyl tape.

WHEN HANDLING VIDEO CASSETTES

- Do not expose video cassettes to extreme heat, high humidity, or strong magnetic fields.
- Do not tamper with the cassette mechanism.
- Do not touch the tape with your fingers.
- Always store an unused cassette in its case.

LOADING

Hold the cassette with the arrow side up (top). Insert the cassette gently into the slot in the direction of the arrow (on the cassette) until the loading mechanism automatically pulls the cassette into the unit. Make certain that the cassette is inserted correctly.

- If the cassette is not loaded correctly, the VCR will eject the cassette automatically after approximately 3 seconds.

UNLOADING

Press the **STOP/EJECT** button twice. The cassette will be ejected automatically. After the cassette is visible in the tape slot, pull it out to remove it.

- Unloading the cassette is possible only when the power cord is connected to the wall outlet.
- The cassette can be ejected when the **STOP/EJECT** button is pressed, even if the VCR's power is OFF.

NORMAL PLAYBACK

PREPARATION

- Turn on the power of both the VCR and the monitor.
- If you have a TV instead of monitor, turn on the power of TV and then set the TV's source selector to VIDEO.

NORMAL PLAYBACK

- 1 Insert a prerecorded video cassette.

The  indicator will light and the VCR will power-up automatically.

- If a tape without a record protect tab is inserted, the unit will start the playback automatically.

- 2 Press the **PLAY/REC CHK** button.

Press **REC/PB SPEED (DOWN or UP)** button to choose the desired time mode.

The select time is displayed in the VCR indicator panel. Select the time while the tape is stopped or being played back.

6H → 18H → 30H → 72H → 96H → 120H → 168H → 240H → 480H → 960H

- The time mode can not be changed while the tape is playing back in 2H or 4H.
- If the tape reaches the end before **STOP/EJECT** is pressed, the VCR will automatically stop and rewind.

- 3 Press the **STOP/EJECT** button to stop playback.

TRACKING CONTROL

If noise appears on the screen during playback, press either **TRACKING (MOVE / SEL)** buttons until the noise on the screen is reduced.

- In case of vertical jitter, adjust these controls very carefully.
- Tracking is automatically reset to normal when the tape is ejected.

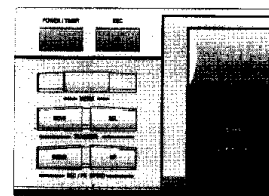
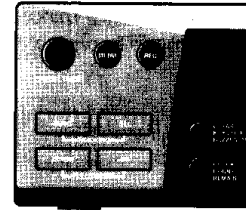
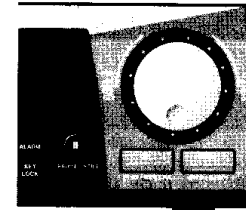

NOTES:

- Ensure that the selected tape recording and playback times match one another.
- A picture may vibrate vertically, but this is normal.
- A distortion may appear on the top of the screen, but this is normal.
- A sound may be muted during playback, but this is normal.
- If the recording hour and playback hour are different, the sound may not play back normally. (Set the **AUDIO PLAY** to OFF mode on the VCR SET UP menu.)

SPECIAL EFFECTS PLAYBACK

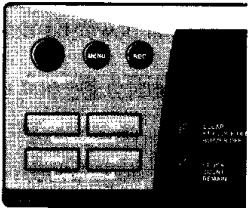
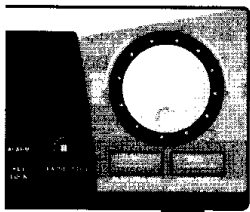

TO WATCH A STILL PICTURE

During **PLAYBACK** mode...

- 1 Press the **PAUSE/STILL** button.

Still picture will appear on the monitor.

- If a still picture vibrates vertically, stabilize it by pressing the **TRACKING (MOVE / SEL)** buttons.
- If the VCR is left in the **STILL** mode for more than 5 minutes, the VCR will automatically enter the **STOP** mode to protect the tape and video heads.

- 2 To continue normal playback, press the **PLAY/REC CHK** button.

TO WATCH A FIELD ADVANCE PICTURE

During **PLAYBACK** mode...

- 1 Press the **PAUSE/STILL** button.
- 2 Rotate the **JOG** dial to forward / reverse or press **PAUSE/STILL** button repeatedly.

The picture will slowly advance to forward or reverse field by field.

- 3 To continue normal playback, press the **PLAY/REC CHK** button.

TO SEARCH ALARM RECORDING

During **STOP** mode...

- 1 Press the **PAUSE/STILL** button.

The **INDEX** indicator will appear in the VCR indicator panel.

- 2 Rotate and release the **SHUTTLE** ring to forward or reverse.

Alarm video will play for 5 seconds and then search to the next alarm recording.

SPECIAL EFFECTS PLAYBACK (cont'd)

SHUTTLE RING

During Still mode...

- 1 Rotate the **Shuttle Ring** to forward or reverse.
- 2 Rotate **Shuttle Ring** toward **FF** to advance the tape, or toward **REW** to reverse the tape. How far you rotate and hold the shuttle ring determines the speed at which the tape moves.

Rotate **Shuttle Ring** for variable speed adjust from Slow to Search in the direction chosen.

- 3 Release the **Shuttle Ring** to return to **STILL** mode.

- 4 Press **PLAY/REC CHK** to return to normal playback speed.

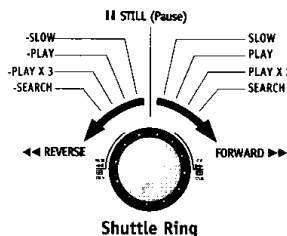

NOTES:

- During **STOP** mode, rotate and release the Shuttle ring to rewind or fast forward the tape.
- If the Shuttle Ring is used during the normal playback, the playback mode is changed between the double speed play and forward search on the forward direction, and among the reverse play, reverse triple-speed play, and reverse search on the reverse direction. Releasing the ring resumes a normal playback mode.

JOG DIAL

During Still mode...

- 1 Move **Jog Dial** with finger toward **FF** to advance tape frame-by-frame, or toward **REW** to reverse tape frame-by-frame. Movement of the **Jog Dial** one "click" moves the tape by one frame. How "fast" you move the **Jog Dial** determines how fast the frame-by-frame movement occurs.

- 2 Press **PLAY/REC CHK** to return to normal playback speed.

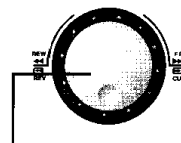

Jog Dial

Move **Jog Dial** for frame-by-frame tape playback forward or reverse.

NOTES:

- Horizontal lines (noise bars) will appear on the monitor screen, but this is normal.
- The audio is automatically muted during special effect modes, so there is no sound during search.
- During the high-speed picture search modes, a short period is needed to stabilize tape speed when re-entering the **PLAY** mode. Slight interference may be observed during this period.

TAPE COUNTER MEMORY FEATURE

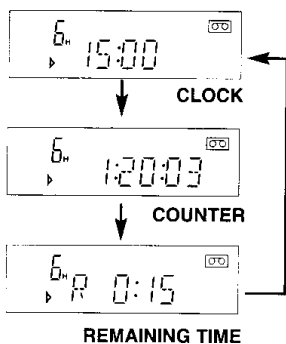

REAL TIME COUNTER

During **PLAYBACK** or **RECORDING** mode...

Press the **CLOCK/COUNT/REMAIN** button.

Whenever you press the **CLOCK/COUNT/REMAIN** button, time and counter are displayed alternately in the VCR indicator panel.

When the **COUNTER** is displayed...

- Counter changes to **TIME** when the cassette is ejected.
- The real-time counter does not operate when nothing is recorded on the tape.

COUNTER MEMORY FUNCTION

This function is only provided when **COUNTER** is displayed in the VCR indicator panel.

1 Begin recording or playing a tape.

Continue to play or record.

2 At the point where you want playback to begin, reset the real-time counter to 0:00:00 by pressing the **CLEAR** button once.

The VCR will stop at the **COUNTER** position 0:00:00.

3 Press the **STOP/EJECT** button when recording or playback finishes.

4 Rotate and release the **SHUTTLE** ring to reverse.

TAPE REMAINING

This function allows the time of the remaining tape to be displayed during recording or playback.

1 Press the **CLOCK/COUNT/REMAIN** button until the remaining time displays on the VCR indicator panel.

2 Start recording or playback.

- The remaining time is not display during more than "72H" recording mode.

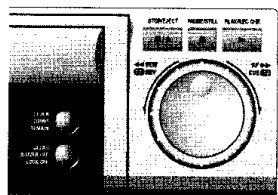
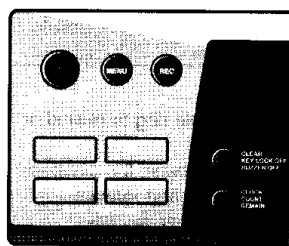

NORMAL RECORDING

PREPARATION

- Turn on the power of both the VCR and the monitor.
- If you have a TV instead of monitor, turn on the power of TV and then set the TV's source selector to VIDEO.

1 Insert the **VIDEO CASSETTE** that has the safety tab in place.

2 Press **REC/PB SPEED (DOWN or UP)** to choose the desired recording mode.

The selected time is displayed in the VCR indicator panel.

6H → 18H → 30H → 72H → 96H → 120H →
168H → 240H → 480H → 960H → 000H

- If you select the "000H" REC TIME, the **INTERVAL** time mode is changed on the **REC MODE SET UP** menu as below, to the second unit.

10 SEC → 20 SEC → 30 SEC → 1 MIN → 2 MIN → 3 MIN → AUTO

- If you select **AUTO**, this unit records when the external **1-SHOT REC** signal is input.

3 Press the **REC** button.

Recording will start.

(The REC indicator will appear in the VCR indicator panel.)

4 Press the **STOP/EJECT** button to stop recording.

To PAUSE the recording

During the **RECORDING** mode...

1 Press the **PAUSE/STILL** button to pause the tape.

2 When you want to continue recording, press the **PAUSE/STILL** button again.

- After 5 minutes in pause mode, the tape will be stopped automatically to protect the tape and the video heads.

To Record Check

When in record mode, pressing the **PLAY/REC CHECK** should cause the unit to reproduce recently recorded video.

During the **RECORDING** mode...

Press **PLAY/REC CHECK** to reproduce recently recorded video.

During the Record Check, the unit can't record at all. After the Record Check, the unit returns to the original recording mode.

REC MODE	
▶ REC TIME	6H
TRIGGER OUT	1 FIELD
SERIES	OFF
REPEAT OPTION :	STOP AT EOT.
(MOVE) (SELECT) (MENU)	

REC MODE	
REC TIME	000H
▶ INTERVAL	10SEC
TRIGGER OUT	1 FIELD
SERIES	OFF
REPEAT OPTION :	STOP AT EOT.
(MOVE) (SELECT) (MENU)	

REPEAT RECORDING

This function is used to select various options before starting a recording.

Things to know before starting

- Make sure a tape is in the each VCR and the safety tab is in place otherwise, the tape will be automatically ejected.
- Turn on the power of both the VCR and the monitor.

MAIN MENU

```

MENU
VCR SET UP
▶ REC MODE SET UP
  TIMER REC SET UP
  ALARM SET UP
  POWER FAIL RECALL
  LANGUAGE ENGLISH
(MOVE) (SELECT) (MENU)
    
```

REC MODE MENU

```

REC MODE
REC TIME          6H
TRIGGER OUT      1 FIELD
SERIES           ON
▶ REPEAT OPTION :
  STOP AT EOT.
(MOVE) (SELECT) (MENU)
    
```

1 Press **MENU** button and the main menu will appear.

2 Press the **MOVE** to select **REC MODE SET UP**. Press **SEL**. The **REC MODE** menu will display.

3 Press **MOVE** to choose the **REPEAT OPTION** item. Press **SEL** repeatedly to choose options.

- **STOP AT EOT**: Goes into **STOP** mode when it reaches end of tape in **RECORD** mode.
- **RE-REC EVEN IF ALARM**: Rewinds tape and enters **RECORD** mode at beginning of tape even if there has been alarm.
- **REWIND, STOP**: Rewinds tape and then enters **STOP** mode.
- **STOP IF ALARM**: If there has been alarm, it goes into stop mode when it reaches end of tape in record mode. Otherwise it operates same as **RE-REC** even if alarm mode.

4 Press **MENU** when finished. Press **MENU** repeatedly to exit menu screen.

5 Press **REC** button.
The VCR will start recording.

- We do not recommend repeat recording for security applications.

TIMER RECORDING

This VCR can be programmed to record up to 8 programs. For programmed recording, the timer must be set for the starting and ending times.

PREPARATION

- Make sure a tape is in the VCR and the safety tab is in place otherwise the tape will be automatically ejected.
- Turn on the power of both the VCR and the monitor.
- If you have a TV instead of monitor, turn on the power of TV and then set the TV's source selector to **VIDEO**.

1 Press **MENU** and the main menu will appear.

2 Press the **MOVE** to choose the **TIMER REC SET UP** item.

3 Press **SEL** to enter the **TIMER REC SET UP** menu.

The **TIMER REC SET UP** menu will appear.

4 Press **SEL** to select the **SET** item then press **DOWN** or **UP** to choose **ON** or **OFF**. Activated **Timer Recording** only when the **SET** item is set to "ON".

5 Press **SEL** to move to next item and then set the next items (day, start time, end time recording hour) by using **UP**, **DOWN** and **SEL** buttons.

DAY option

SUN-SAT: Same time once a week.

M-F or S-S: Same time during Monday ~ Friday or Saturday ~ Sunday

DLY: Same time(s) every day

6 Press **MENU** when finished. Press **MENU** repeatedly to exit menu screen.

If you are finished programming and you want to set the VCR to record the programs you have entered. **A) MAKE SURE YOU HAVE INSERTED A TAPE INTO THE VCR. B) YOU MUST PRESS TIMER BUTTON BEFORE IT WILL RECORD ANY TIMER PROGRAMS (TIMER appears)**. The VCR is now set to record the preset programs.

MAIN MENU

```

MENU
VCR SET UP
REC MODE SET UP
▶ TIMER REC SET UP
  ALARM SET UP
  POWER FAIL RECALL
  LANGUAGE ENGLISH
(MOVE) (SELECT) (MENU)
    
```

TIMER REC MODE MENU

```

SET DAY START END SPD
▶ OFF ---:---:---:---: 6
OFF ---:---:---:---: 6
OFF ---:---:---:---: 6
OFF ---:---:---:---: 6
OFF ---:---:---:---: 6
OFF ---:---:---:---: 6
OFF ---:---:---:---: 6
OFF ---:---:---:---: 6
(UP) (DOWN) (SELECT) (MENU)
    
```

```

SET DAY START END SPD
▶ OFF SUN 10:30 11:30 [8]
OFF ---:---:---:---: 6
OFF ---:---:---:---: 6
OFF ---:---:---:---: 6
OFF ---:---:---:---: 6
OFF ---:---:---:---: 6
OFF ---:---:---:---: 6
OFF ---:---:---:---: 6
OFF ---:---:---:---: 6
(UP) (DOWN) (SELECT) (MENU)
    
```

NOTES:

- If you want to stop recording during the **Time recording**, press **STOP/EJECT** button more than 3 seconds.
- If you press **TIMER** button, the Time Lapse's power is turned off. After finishing **Time recording**, the Time Lapse's power is turned off again.

SERIES RECORDING

Series Recording mode is convenient when it is necessary to record with two or more VCRs. If you have two VCRs in series recording mode, the second VCR will start to record automatically at the end of the first VCR recording.

Things to know before starting

- Before series recording, refer to page 12 for Series Record connection.
- Make sure a tape is in the each VCR and the safety tab is in place.
- SERIES recording is not available when the Timer recording is in standby mode.
- SERIES and REPEAT OPTION on the REC MODE menu can not be set to ON mode simultaneously.

MAIN MENU

```

MENU
VCR SET UP
▶ REC MODE SET UP
  TIMER REC SET UP
  ALARM SET UP
  POWER FAIL RECALL
  LANGUAGE ENGLISH
(MOVE) (SELECT) (MENU)
    
```

REC MODE MENU

```

REC MODE
REC TIME          6H
TRIGGER OUT      1 FIELD
▶ SERIES          ON
REPEAT OPTION :  STOP AT EOT.
(MOVE) (SELECT) (MENU)
    
```

1 Press **MENU** button and the main menu will appear.

2 Press **MOVE** to choose the REC MODE SET UP item and then press **SEL**.

The REC MODE SET UP menu will appear.

3 Press the **MOVE** to choose the SERIES item. Press **SEL** to choose ON.

4 Press **MENU** when finished. Press **MENU** repeatedly to exit menu screen.

5 Press **REC** button.
The first VCR will start recording.

ALARM RECORDING

Alarm recording will start when the external alarm signal is input. This function is available when the VCR is connected to an external device having an alarm output terminal.

Things to know before starting

- Before alarm recording, refer to page 12 for alarm record connection.
- Make sure a tape is in the VCR and the safety tab is in place.

1 Press **MENU** and the main menu will appear

2 Press the **MOVE** to choose the ALARM SET UP item and then press **SEL**.

The ALARM SET UP menu will appear.

3 Press the **MOVE** to choose the REC MODE item. Press **SEL** repeatedly to choose recording hours.

The recording mode is changed as below.

OFF → 6H → 18H → 30H

4 Press **MOVE** to choose the DURATION item. Press **SEL** repeatedly to choose the desired duration of recording.

The duration of recording is changed as below.

30 SEC → 1 MIN → 3 MIN → 5 MIN → 10 MIN → T.END → AUTO1 → AUTO2

- If you choose the T.END, alarm recording continues until tape ends.
- If you choose the AUTO1, alarm recording continues until the alarm reset signal is input.
- If you choose the AUTO2, alarm recording continues while the alarm signal is input.

MAIN MENU

```

MENU
VCR SET UP
REC MODE SET UP
TIMER REC SET UP
▶ ALARM SET UP
  POWER FAIL RECALL
  LANGUAGE ENGLISH
(MOVE) (SELECT) (MENU)
    
```

ALARM SET UP

```

ALARM SET UP
▶ REC MODE          6H
  DURATION          1 MIN
  BUZZER            ON
  ALARM READY       ON
  ALARM RECALL
(MOVE) (SELECT) (MENU)
    
```

ALARM RECORDING (cont'd)

ALARM SET UP

ALARM SET UP	
REC MODE	6H
DURATION	1 MIN
▶ BUZZER	ON
ALARM READY	ON
ALARM RECALL	ON

(MOVE) (SELECT) (MENU)

ALARM SET UP	
REC MODE	6H
DURATION	1 MIN
▶ BUZZER	ON
ALARM READY	ON
ALARM RECALL	ON

(MOVE) (SELECT) (MENU)

5 Press **MOVE** to choose the **BUZZER** item. Press **SEL** repeatedly to switch buzzer function during alarm recording.

- While the alarm is in process, the buzzer will ring. If you want to stop buzzer, press and hold **BUZZER OFF** button.

6 Press **MOVE** to choose the **ALARM READY** item. Press **SEL** repeatedly to switch alarm ready function.

- When selected "ON" and the alarm input is triggered, the unit will go to alarm record mode from either STOP, POWER OFF or RECORD modes.
- When selected "OFF" and the alarm input is triggered, the unit will go to alarm record mode only from the RECORD mode (including Timer Record). If the unit is in STOP or POWER OFF mode, it will ignore the alarm input command.

7 Press **MENU** when finished. Press **MENU** repeatedly to exit menu screen.

- *ALARM indicator in VCR indicator panel blinks when alarm recording is proceeding.*

NOTES:

- When you select ALARM REC MODE ON (6H, 18H, 30H), the ALARM indicator will light in VCR indicator panel.
- You can not stop during ALARM REC MODE.

For example: When the Alarm REC MODE is set to 6H

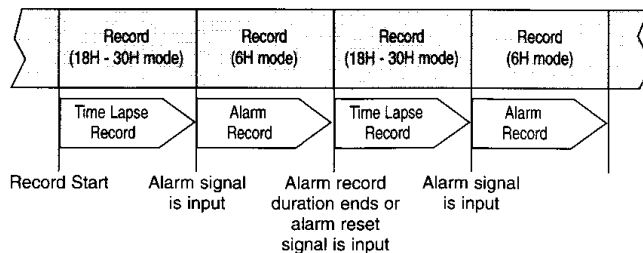

CHECK THE ALARM RECORD INFORMATION

MAIN MENU

MENU	
VCR SET UP	
REC MODE SET UP	
TIMER REC SET UP	
▶ ALARM SET UP	
POWER FAIL RECALL	
LANGUAGE ENGLISH	

(MOVE) (SELECT) (MENU)

ALARM REC MODE MENU

ALARM SET UP	
REC MODE	6H
DURATION	1 MIN
BUZZER	ON
ALARM READY	ON
▶ ALARM RECALL	

(MOVE) (SELECT) (MENU)

ALARM RECALL	
1	01/01/03 00:21:13
▶ 2	01/02/03 04:07:37
3	01/03/03 03:59:36
4	--/--/-- --:--:--
5	--/--/-- --:--:--
6	--/--/-- --:--:--
7	--/--/-- --:--:--
8	--/--/-- --:--:--

(UP) (DOWN) (CLEAR) (MENU)

To check or cancel the Alarm Record Information, use the ALARM RECALL function.

1 Press **MENU** button and the main menu

2 Press **MOVE** to choose the **ALARM SET UP** and then press **SEL**.

ALARM SET UP menu will appear.

3 Press **MOVE** to choose the **ALARM RECALL** and then press **SEL**.

ALARM RECALL menu will appear.

To erase the alarm record information

If you want to erase the alarm record information, press the **CLEAR** button.

4 Press **MENU** when finished. Press **MENU** repeatedly to exit menu screen.

NOTES:

- Alarm recall can memorize up to 16 alarms, but only 8 can be displayed on the monitor. Press **MOVE** repeatedly to see the next page.

RECORDING TIME TABLE INFORMATION

Recording Time	Field / sec
6H	50
18H	20
30H	12
72H	4.62
96H	3.53
120H	2.86
168H	2.07
240H	1.46
480H	0.74
960H	0.37

CHECK THE POWER FAIL RECALL

To check or cancel the POWER FAIL RECALL while you are play-back or stop mode, use the POWER FAIL RECALL function.

MAIN MENU

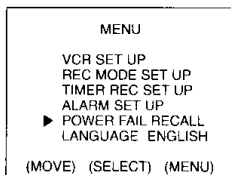

POWER FAIL INFORM MENU

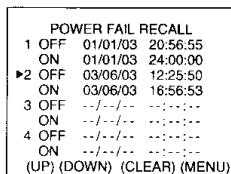

1 Press **MENU** and the main menu will appear.

2 Press **MOVE** button to choose the **POWER FAIL RECALL** item.

3 Press **SEL** to enter the **POWER FAIL RECALL** menu.

POWER FAIL RECALL menu will appear.

- Power fail information will display up to 8 occurrences.

To erase the power fail recall

If you want to erase the power fail recall, select a power fail recall item to erase and then press the **CLEAR** button. The power fail recall is erased.

4 Press **MENU** when finished. Press **MENU** repeatedly to exit menu screen.

KEY LOCK FUNCTION

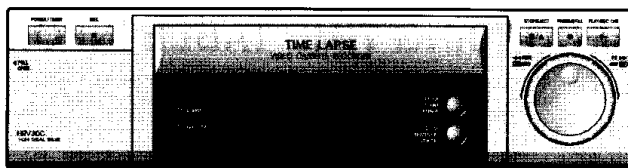

KEY LOCK indicator

LOCK OFF button

- When the external alarm signal is input the VCR is activated to KEY LOCK mode to protect unauthorized persons using the VCR. The KEY LOCK indicator lights and any button except **LOCK OFF** button is not be operated.
- Press and hold **LOCK OFF** button for more than 3 seconds to release KEY LOCK mode.

SELF-DIAGNOSIS

This function informs you of error messages to help solve problems more easily.

When the VCR malfunctions, an error code is displayed in the VCR indicator.

ERROR CODE TABLE

DISPLAY	DESCRIPTION	INPUT SIGNAL	CIRCUIT STATUS	SERVICE POINTS
E-1	Loading Motor Error	• Mode Switch S1,S2,S3,S4 • Load Motor +, -	• Mode Switch Position not changed within 6 seconds after cassette loading attempt.	• Loading Motor Drive IC • Loading Motor • Mode Switch
E-2	Tape Loading Error	• Mode Switch S1,S2,S3,S4 • Load Motor +, -	• Mode Switch Position not changed within 6 seconds after cassette loading attempt.	• Mode Switch contacts
E-3	Tape Eject Error	• Mode Switch S1,S2,S3,S4 • CST IN Switch • Load Motor +, -	• CST Switch must be activated within 3 seconds, otherwise unit shut down will occur.	• CST IN Switch contacts
E-4	Reel Rotational Error	• Supply/Take-up Reel Pulses • CFG	• CFG Signal present, but take-up pulses are missing. (Capstan motor running.)	• Capstan belt • Idler and reel gears damaged
E-5	Drum Motor Error	• DFG Switch • DPF	• Drum Motor (Slow Start) • Motor must be up to speed within 3 seconds of operation.	• Drum Motor and Control Circuits

- When a malfunction occurs in the VCR, press the **POWER/TIMER** button on the front of VCR to operate normally.
- An error message (Err) appears in the display continuously when any button is depressed; contact your dealer or service center.

SERVICE GUIDE TABLE

Unit is Hour.

NO.	DESCRIPTION	1500	3000	5000	6000	7500	9000	10000	12000
1	DRUM ASSY	●	●	◆	●	●	●	◆	●
2	MOTOR CAPSTAN (D-35)	●	●	●	◆	●	●	●	◆
3	BELT CAPSTAN								◆
4	BASE ASSY A/C	●	●	●	●	●	●	●	◆
5	HEAD F/E	●	●	●	●	●	●	●	◆
6	ARM ASSY IDLER							◆	
7	HOLDER ASSY PINCH				◆				◆
8	BAND ASSY TENSION								◆
9	HOUSING ASSY	▲	▲	▲	▲	▲	▲	▲	◆
10	CAPSTAN SOFT BRAKE				◆				◆

Reference:

◆: Changing ●: Cleaning ▲: Checking



Notes:

- Check the running path adjustment when you change items 1, 2, 4, 5 and 10.
- Check the back tension when you change Band Assy Tension.

VIDEO HEAD CLEANING

- Dirt accumulating on the head after a long period of time can cause the playback picture to become blurred or broken up. High quality video cassette tapes will not normally deposit dirt onto the video head, but old or damaged tapes might. Clean the video heads with a commercially available video heads cleaning tape.

TROUBLESHOOTING

SYMPTOM	CHECK POINT & CORRECTION
Cassette cannot be inserted.	<ul style="list-style-type: none"> • Load cassette in direction indicated by arrow on cassette. • A cassette is already in the VCR. • Check if power indicator is lit on the VCR indicator panel. If not, make sure power cord is plugged in. • If the  indicator flashes, press the POWER/TIMER button again.
The VCR will not go into the recording mode, even when REC button is pressed.	<ul style="list-style-type: none"> • The cassette has had the erase prevention tab removed. Stick a piece of cellophane tape over the erase prevention tab hole or select a different cassette.
No picture appears on monitor screen when PLAY/REC CHK button is pressed.	<ul style="list-style-type: none"> • Try a different cassette tape. • Try to confirm that the system is connected correctly.
No picture, but audio is clear.	<ul style="list-style-type: none"> • The heads may require cleaning. • Take VCR to a qualified Service Center for service.
Interference on playback picture.	<ul style="list-style-type: none"> • Adjust fine tuning knob on monitor to obtain best picture. • Adjust TRACKING (MOVE / SEL) control button. • Take VCR to Service Center for service.
VCR does not start at preset record starting time.	<ul style="list-style-type: none"> • Setup recording time according to instructions.
The tape is ejected in the timer or alarm recording mode.	<ul style="list-style-type: none"> • The cassette has had the erase prevention tab removed. Stick a piece of cellophane tape over the erase prevention tab hole or select a different cassette.
 indication flashes.	<ul style="list-style-type: none"> • Insert a cassette.

Using the **RESET** button (located at the rear panel of VCR)

This button is used to solve the problems exhibited by the following symptoms :

- When the power cannot be turned on, even if the power cord is connected to the outlet.
 - When the VCR's display does not display.
 - When the VCR does not operate normally.
- Use a pencil or ballpoint pen to press the **RESET** button.

NOTES:

- If the **RESET** button is pressed, then all memorized data will be cleared, such as timer program, present time, alarm information, etc.
- If the present time is cleared, set the clock again.

SPECIFICATIONS

GENERAL

Head System	Four head helical scan azimuth system
Power Source	AC 100-240V, 50/60Hz
Power Consumption	Approx. 15 Watts
Back up time (clock)	30 days
Dimensions (WxHxD)	14.2" x 3.7" x 10.7" (360 x 94 x 273 mm)
Operating Temperature	41 °F-105 °F (5 °C-40 °C)
Operating Humidity	Less than 80% RH
Timer	24-hour display type
Weight	Approx. 8.4 lb (3.8 kg)
Tape Speed	11.12 mm/sec (6H) , 3.70 mm/sec (18H), 2.22 mm/sec (30H), 72H ~ 960H
Maximum Recording Time	6 hours (T-120, 6H), 18 hours (T-120, 18H), 30 hours (T-120, 30H), 72H ~ 960H
Tape Width	0.5 in. (12.7 mm)
Rewind Time	About 65 seconds (T-120)
Video Signal System	EIA Standard (525 lines, 60 fields) NTSC type color signal
Video Input	1.0 Vp-p 75 ohms unbalanced
Video Output	1.0 Vp-p 75 ohms unbalanced
Signal to Noise Ratio	More than 43 dB (6H mode)
Conventional audio	
Input (LINE)	-6.0 dBm more than 47 kohms
Output (LINE)	-6.0 dBm less than 1.5 kohms
S/N Ratio	More than 43 dB (6H mode)
Frequency Range	200 Hz to 10kHz (6H mode)

* Designs and specifications are subject to change without notice.

* Weight and dimensions shown are approximate.

“Intelligent”

Time-Lapse Recorder

(NTSC SYSTEM)

INSTRUCTION MANUAL

Real Time & High Density

